

Core Conductor Model

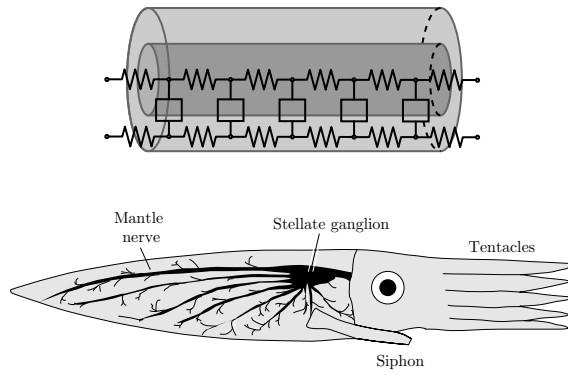

Figure 1.28

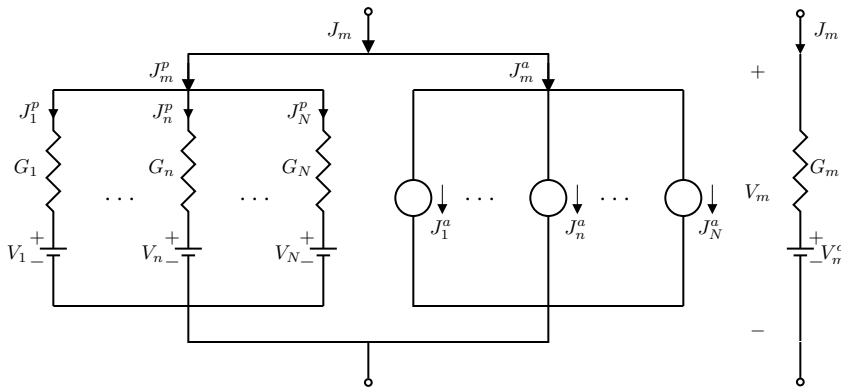

Figure 7.33

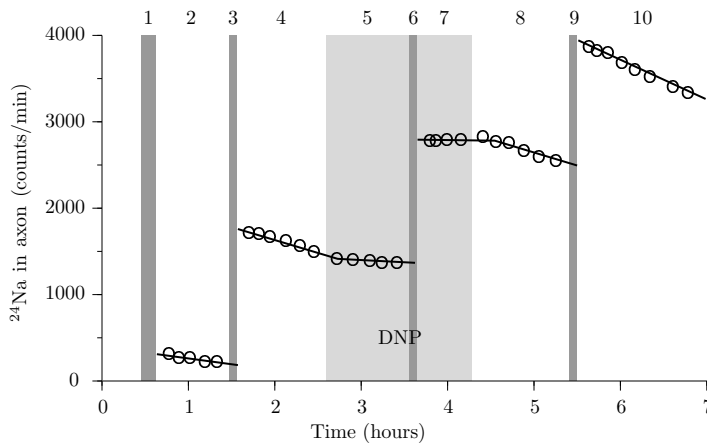

Figure 7.38

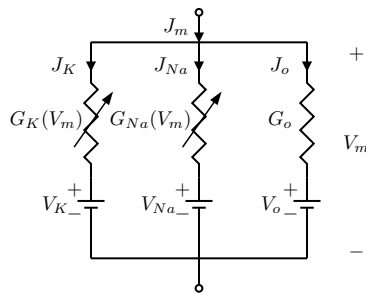

Figure 7.32

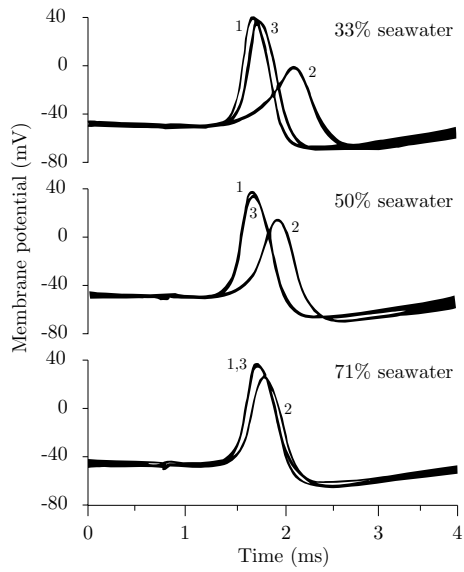
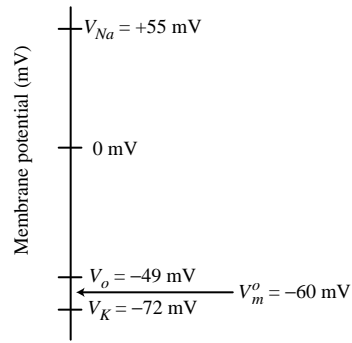

Figure 4.2

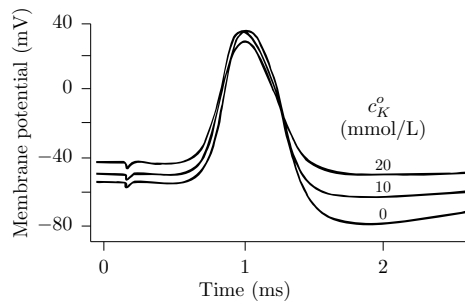

Figure 4.5

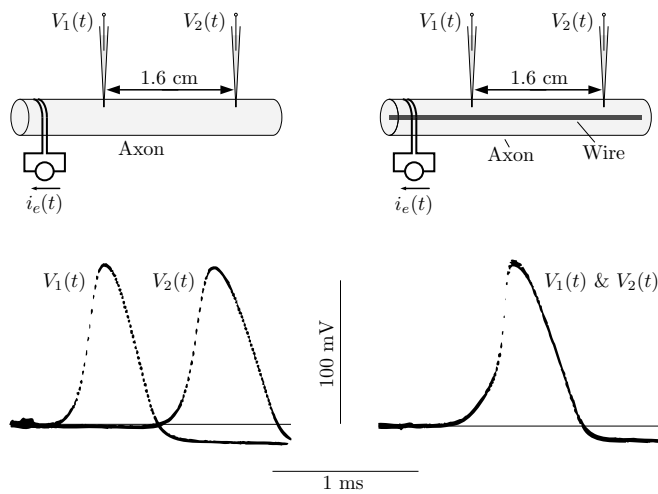

Figure 2.15

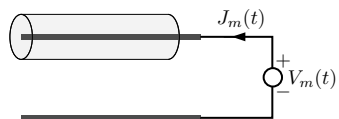

Figure 4.10

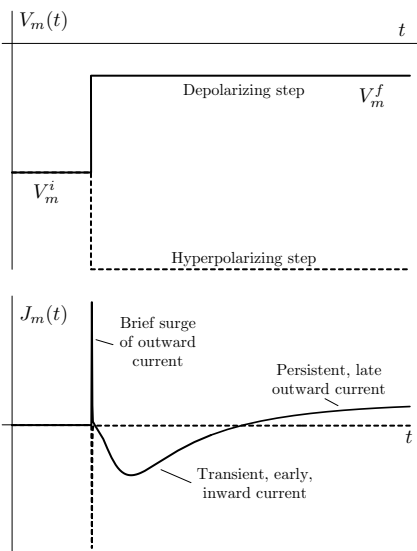

Figure 4.12

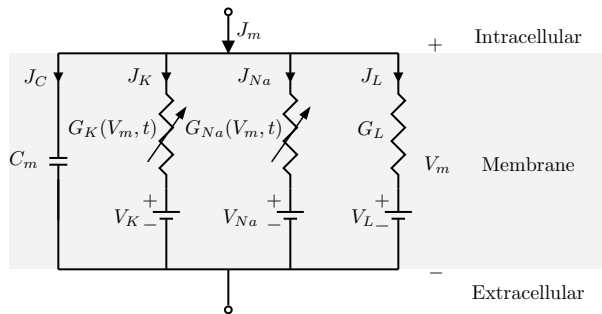

Figure 4.6

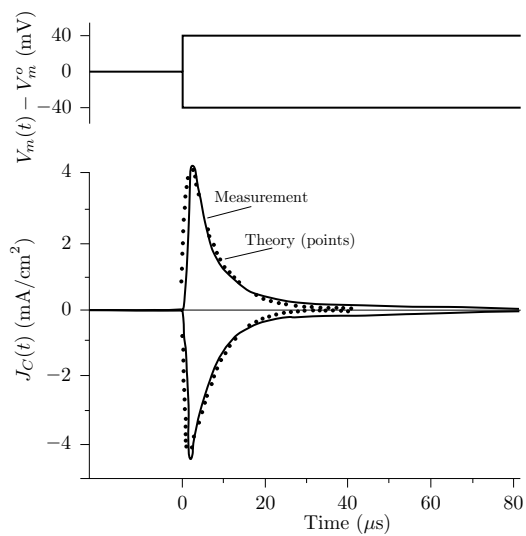

Figure 4.13

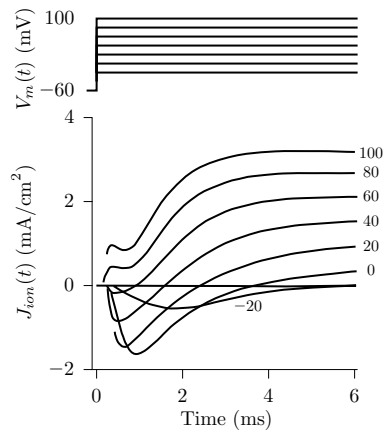

Figure 4.14

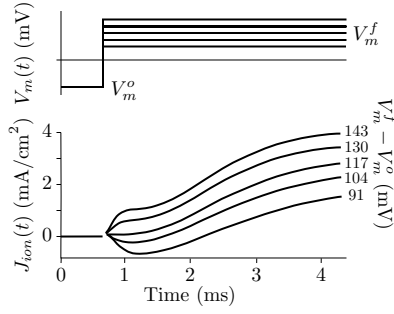

Figure 4.15

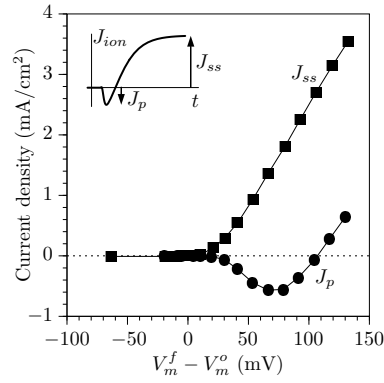

Figure 4.16

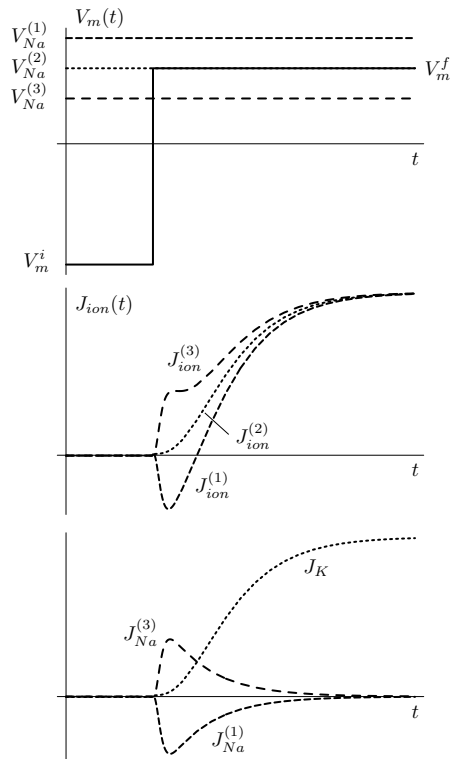

Figure 4.17