

Figure 7.18

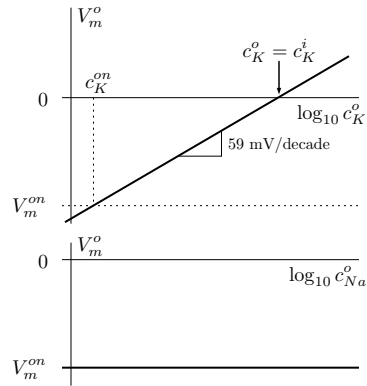

Figure 7.19

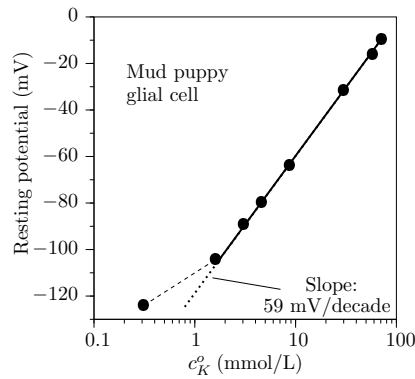

Figure 7.21

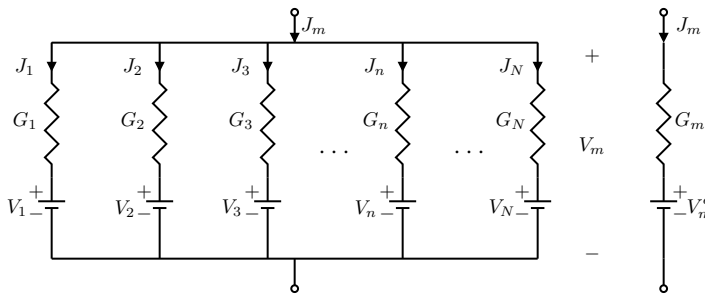

Figure 7.24

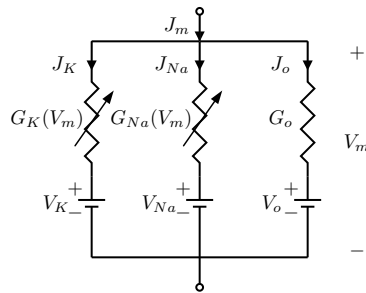

Figure 7.32

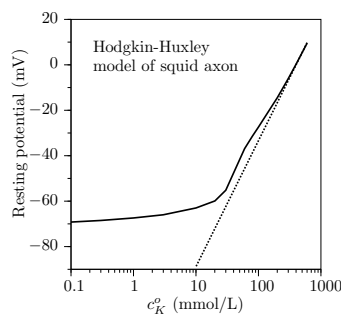

Figure 7.29

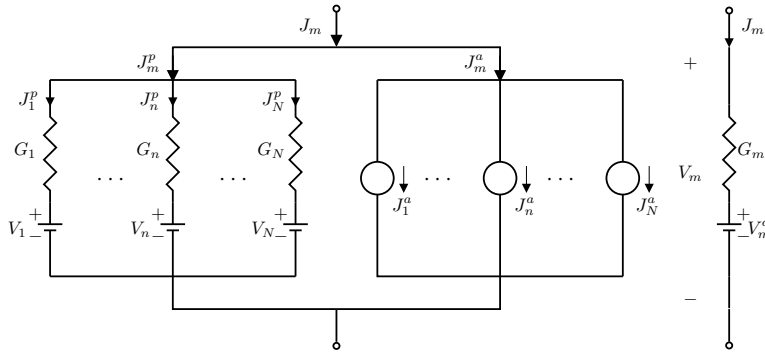

Figure 7.33

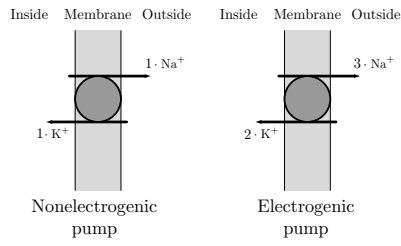

Figure 7.34

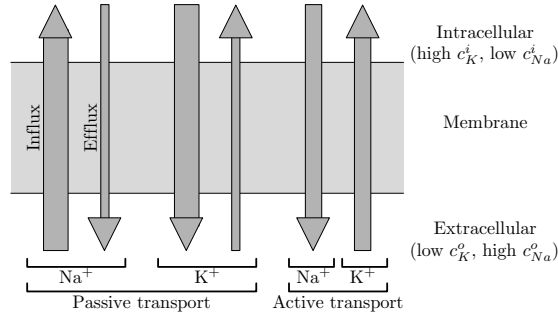

Figure 7.35

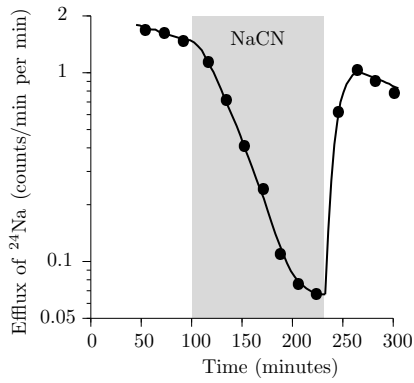

Figure 7.36

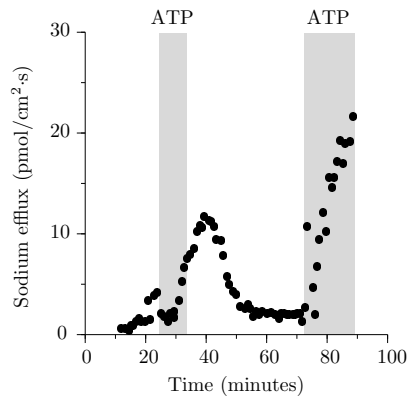

Figure 7.39

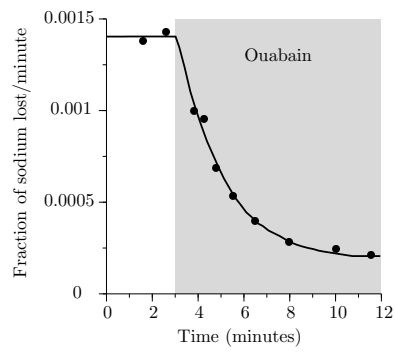

Figure 7.41

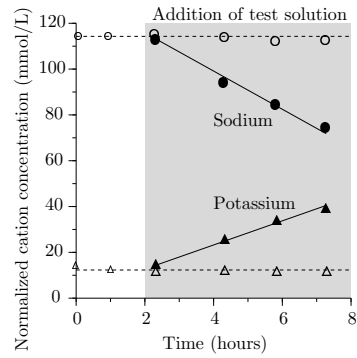

Figure 7.42

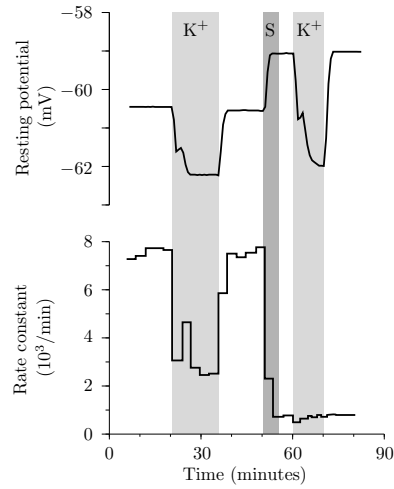

Figure 7.44

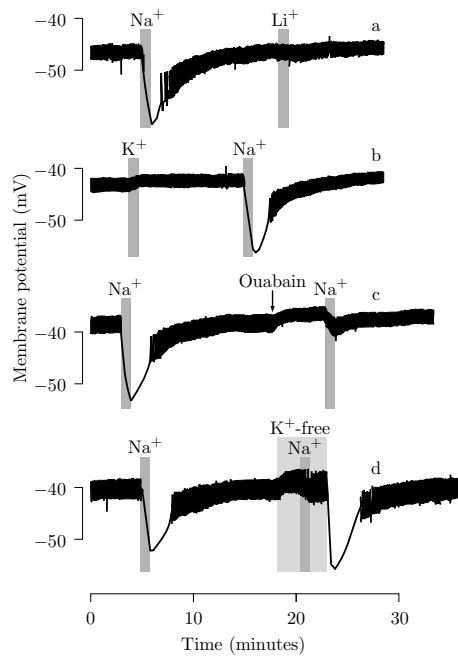

Figure 7.45

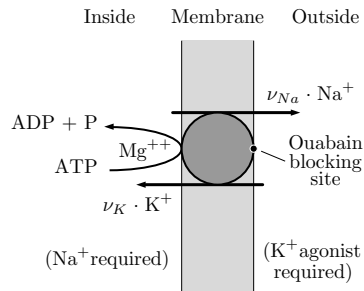

Figure 7.50

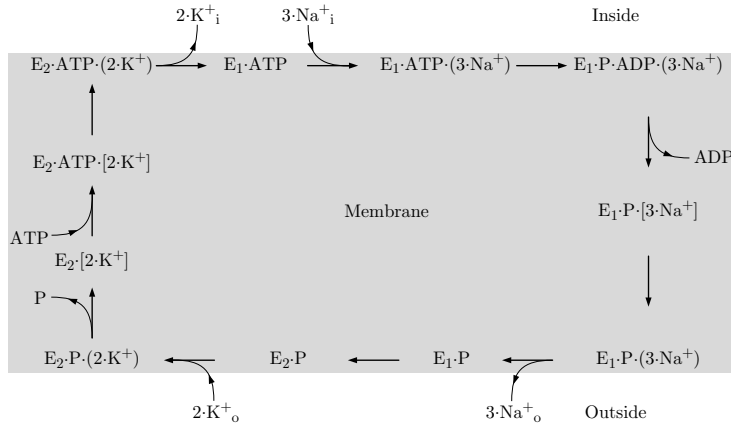
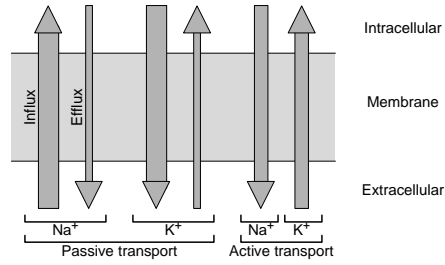
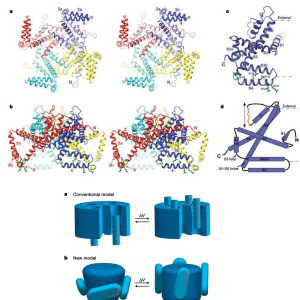

Figure 7.51



Family of related "channels"



Y. Jiang, A. Lee, J. Chen, V. Ruta, M. Cadene, B. Chait, and R. MacKinnon (2003), Nature 423:33-41.

Family of related "pumps"

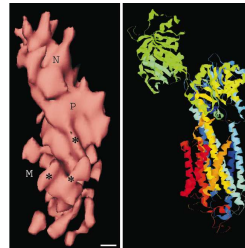

H. Hebert, P. Purhonen, H. Vorum, K. Thomsen, and A.B.B. Maunsback (2001), J. Mol. Biol. 314:479-494.

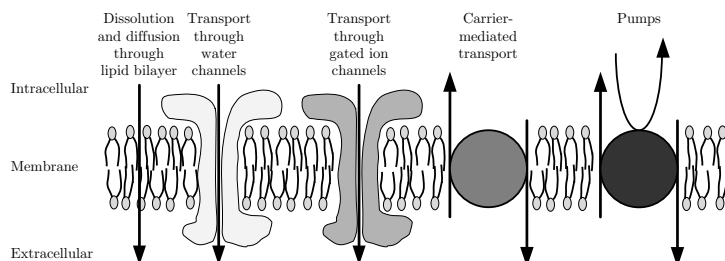

Figure 2.19